

XT230A1PAL2

Capacitive proximity sensors XT, cylindrical M30, plastic, Sn 15 mm, cable 2 m



Main

Range of Product	Telemecanique Capacitive proximity sensors XT
Sensor Type	Capacitive proximity sensor
Product Specific Application	Detection of insulated or conductive materials
Sensor name	XT2
Sensor design	Cylindrical M30
Size	74.5 mm
Body type	Fixed
Detector flush mounting acceptance	Non flush mountable
Material	Plastic
Enclosure Material	Plastic
Type of output signal	Discrete
Wiring Technique	3-wire
[Sn] nominal sensing distance	0.59 in (15 mm)
Discrete output function	1 NO
Output circuit type	DC
Discrete output type	PNP
Electrical connection	Cable
Cable length	6.56 ft (2 m)
[Us] rated supply voltage	12...24 V DC reverse polarity protection
Maximum delay response	10 ms
IP degree of protection	IP67 double insulation conforming to IEC 60529

Complementary

ISO thread	M30 x 1.5
Detection face	Frontal
[Sa] assured operating distance	0.00...0.43 in (0...11 mm)
Adjustment zone	0.00...0.67 in (0...17 mm)
Differential travel	< 1...20 % Sr
Repeat accuracy	< 5 % Sr
Wire insulation material	PVC
Status LED	Output state indication 1 LED yellow)
Supply voltage limits	10...30 V DC
Maximum residual current	100 mA open state
Protection Type	Short-circuit protection
Switching frequency	<= 150 Hz
Maximum voltage drop	<2.5 V closed)
Current consumption	< 15 mA
Maximum delay first up	100 ms
Maximum delay recovery	10 ms
Maximum switching current	200 mA
Marking	CE
Setting-up	Sensitivity by potentiometer
Threaded length	1.91 in (48.5 mm)

Length	2.93 in (74.5 mm)
Net Weight	0.60 lb(US) (0.27 kg)

Environment

Standards	IEC 60947-5-2
Product Certifications	cULus
Ambient Air Temperature for Operation	14...140 °F (-10...60 °C)
Vibration resistance	10 gn 1 mm 10...55 Hz)IEC 60068-2-6
Shock resistance	30 gn 11 ms IEC 60068-2-27
Resistance to electrostatic discharge	4 kV contact IEC 61000-4-2 8 kV air IEC 61000-4-2
Resistance to electromagnetic fields	2.74 V/m (3 V/m) IEC 61000-4-3
Resistance to fast transients	2 kV IEC 61000-4-4

Ordering and shipping details

Category	US10DS222490
Discount Schedule	0DS2
GTIN	3389119026048
Returnability	No
Country of origin	CN

Packing Units

Unit Type of Package 1	PCE
Number of Units in Package 1	1
Package 1 Height	0.98 in (2.5 cm)
Package 1 Width	8.27 in (21 cm)
Package 1 Length	5.91 in (15 cm)
Package 1 Weight	5.64 oz (160 g)

Offer Sustainability

California proposition 65	WARNING: This product can expose you to chemicals including: Diisononyl phthalate (DINP), which is known to the State of California to cause cancer, and Di-isodecyl phthalate (DIDP), which is known to the State of California to cause birth defects or other reproductive harm. For more information go to www.P65Warnings.ca.gov
REACH Regulation	REACH Declaration
REACH free of SVHC	Yes
EU RoHS Directive	Pro-active compliance (Product out of EU RoHS legal scope) EU RoHS Declaration
Toxic heavy metal free	Yes
Mercury free	Yes
RoHS exemption information	Yes

Contractual warranty

Warranty	18 months
----------	-----------

Dimensions

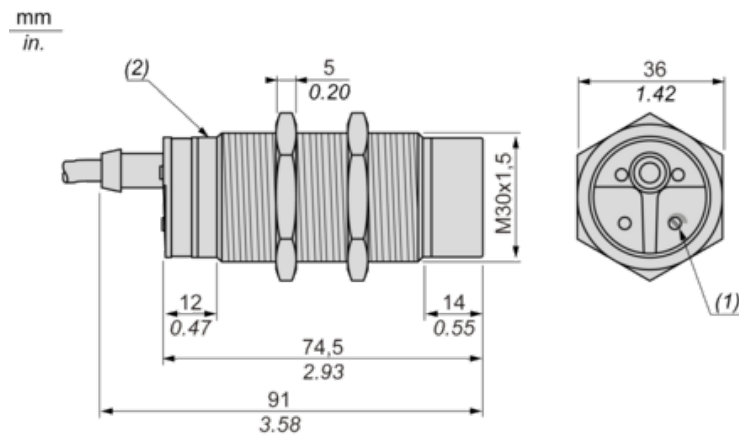

(1) Adjustment potentiometer

(2) LED

Setting-up

Minimum Mounting Distances (mm)

Side by side

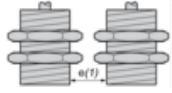

$$e(1) \geq 60$$

Face to face

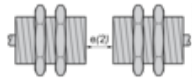

$$e(2) \geq 90$$

Facing a metal object

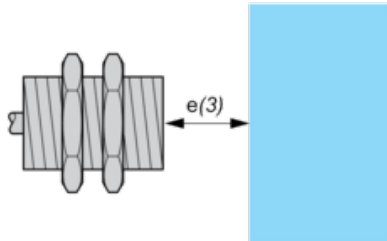

$$e(3) \geq 45$$

Mounted in support

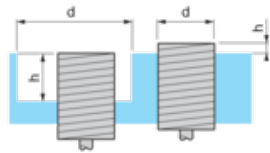

$$d \geq 90$$

$$h \geq 30$$

Fixing nut tightening torque: 8 N.m

Adjustment

Sensitivity Adjustment

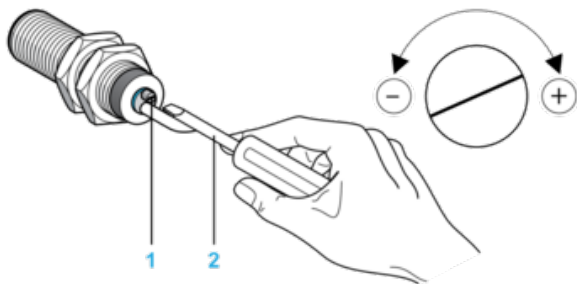

(1) Adjustment potentiometer

(2) Screwdriver (included with sensor)

Wiring Diagram

Pre-cabled

3-wire DC, PNP NO Output

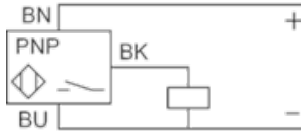

(BU) Blue

(BN) Brown

(BK) Black