

**PRODUCT SPECIFICATIONS**

Elkay Quartz Classic® 33" x 18-1/2" x 9-1/2" Equal Double Bowl Undermount Sink Kit. Sink is molded with up to 80% natural quartz and high performance acrylic resins that are non-porous providing superior heat, scratch, fade and stain resistance. Naturally sound deadening and Rear Center drain placement.



<b>Installation Type:</b>	Sink Kits, Undermount
<b>Material:</b>	Quartz
<b>Finish:</b>	Black (BK), White (WH)
<b>Number of Bowls:</b>	2
<b>Sink Dimensions:</b>	33" x 18-1/2" x 9-1/2"
<b>Bowl 1 Dimensions:</b>	14-1/4" x 16-3/16" x 9-1/2"
<b>Bowl 2 Dimensions:</b>	14-1/4" x 16-3/16" x 9-1/2"
<b>Drain Size:</b>	3-5/8" (92mm)
<b>Drain Location:</b>	Rear Center
<b>Minimum Cabinet Size:</b>	36"
<b>Mounting Hardware:</b>	Part # 54300408 included
<b>Template Included:</b>	Yes
<b>Cutout Template #:</b>	<a href="#">1000003496</a>

Template is available for download at [elkay.com](#). CAD software will be required to open the template.

**Cutout Dimensions for Drop-in Installation:**  
30-9/16" x 16-7/16" (776.22mm x 417.35mm) with 1-1/8" (28.58mm) corner radius



**Included with Product:** ELGU3322 Sink,  
Two LKOBG1516SS Bottom Grids,  
LKQS35 Drain,  
LKQD35 Drain,  
LKCLKIT Cleaning Kit

**▼ Ships in multiple boxes.**

A Century of Tradition and Quality. For more than 100 years, Elkay has been making innovative products and providing exceptional customer care. We take pride in offering plumbing products that make life easier, inspire change and leave the world a better place.



**Product Compliance:** CSA B45.5/IAPMO Z124  
**Accessory:** ASME A112.18.2/CSA B125.2

[Clean and Care Manual \(PDF\)](#)  
[Installation Instructions \(PDF\) - 1000005238](#)  
[Warranty \(PDF\)](#)

**Installation Profile:**

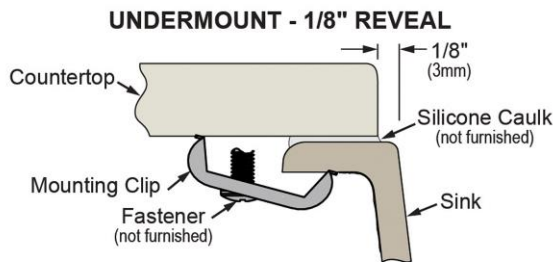



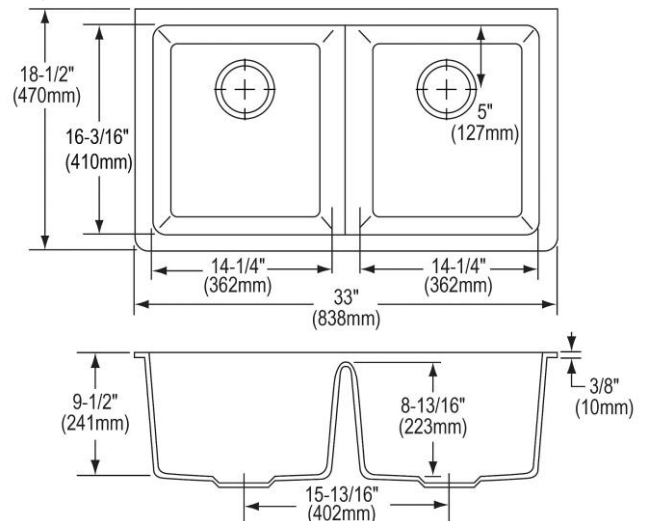

Designed to affix to the underside of any solid surface countertop.

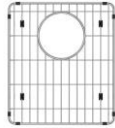

PART: \_\_\_\_\_ QTY: \_\_\_\_\_  
PROJECT: \_\_\_\_\_  
CONTACT: \_\_\_\_\_  
DATE: \_\_\_\_\_  
NOTES: \_\_\_\_\_  
APPROVAL: \_\_\_\_\_

**Included Accessories**

In keeping with our policy of continuing product improvement, Elkay reserves the right to change product specifications without notice. Please visit [elkay.com](#) for the most current version of Elkay product specification sheets. This specification describes an Elkay product with design, quality, and functional benefits to the user. When making a comparison of other producers' offerings, be certain these features are not overlooked.

<a href="#">LKCLKIT</a>	Elkay Sink Cleaning Kit <a href="#">Spec Sheet (PDF)</a>	
<a href="#">LKOBG1516SS</a>	Elkay Stainless Steel 12" x 13-3/4" x 1-1/4" Bottom Grid <a href="#">Spec Sheet (PDF)</a>	
<a href="#">LKQD35</a>	Elkay Polymer 3-1/2" Disposer Flange with Removable Basket Strainer and Rubber Stopper <a href="#">Spec Sheet (PDF)</a>	
<a href="#">LKQS35</a>	Elkay Polymer 3-1/2" Drain Fitting with Removable Basket Strainer and Rubber Stopper <a href="#">Spec Sheet (PDF)</a>	
Optional Accessories		
<a href="#">LKWRB1516SS</a>	Elkay Stainless Steel 11-7/8" x 13-13/16" x 6-15/16" Rinsing Basket <a href="#">Spec Sheet (PDF)</a>	

*In keeping with our policy of continuing product improvement, Elkay reserves the right to change product specifications without notice. Please visit [elkay.com](http://elkay.com) for the most current version of Elkay product specification sheets. This specification describes an Elkay product with design, quality, and functional benefits to the user. When making a comparison of other producers' offerings, be certain these features are not overlooked.*