

# Victaulic® FireLock™ Automatic Sprinklers

⚠ **WARNING**



- Read and understand all instructions before attempting to install any Victaulic products.
- Always verify that the piping system has been completely depressurized and drained immediately prior to installation, removal, adjustment, or maintenance of any Victaulic products.
- Confirm that any equipment, branch lines, or sections of piping that may have been isolated for/ during testing or due to valve closures/positioning are identified, depressurized, and drained immediately prior to installation, removal, adjustment, or maintenance of any Victaulic products.
- Wear safety glasses, hardhat, and foot protection.

Failure to follow these instructions could result in death or serious personal injury and property damage.

- Victaulic® FireLock™ Automatic Sprinklers shall be used only in fire protection systems that are designed and installed in accordance with current, applicable National Fire Protection Association (NFPA 13, 13D, 13R, etc.) standards, or equivalent standards, and in accordance with applicable building and fire codes. These standards and codes contain important information regarding protection of systems from freezing temperatures, corrosion, mechanical damage, etc.
- These installation instructions are intended for an experienced, trained installer. The installer shall understand the use of this product and why it was specified for the particular application.
- The installer shall understand common industry safety standards and potential consequences of improper product installation.

Failure to follow installation requirements and local and national codes and standards could compromise system integrity or cause system failure, resulting in death or serious personal injury and property damage.

## IMPORTANT INSTALLATION INFORMATION

- Victaulic® FireLock™ Automatic Sprinklers shall be installed according to current, applicable Factory Mutual (FM) standards, VdS standards, CEA 4001 standards, National Fire Protection Association (NFPA 13, 13D, 13R, etc.) standards or equivalent standards and in accordance with applicable building and fire codes. Deviations from these standards or alterations to sprinklers (including painting and coating) will void any Victaulic warranty and will impact system integrity. Installations shall meet the provisions of the local authority having jurisdiction and local codes, as applicable, and shall comply with all design specifications.
- Refer to the specific Victaulic product publication for applications and listing information. Product publications can be downloaded at victaulic.com.**
- Transport and store sprinklers in a cool, dry environment in their original packaging. To prevent damage, **DO NOT** empty sprinklers into bags or buckets.
- Size the piping system to meet or exceed the minimum required flow rate for the sprinkler system.
- Per NFPA requirements, flush the system to remove foreign material. Continue to flush the system until water runs clear.
- DO NOT** install sprinkler system piping through heating ducts.
- DO NOT** connect sprinkler system piping to domestic hot water systems.
- DO NOT** allow electrical wiring or other cabling to be hung or wrapped around the sprinkler piping system.
- DO NOT** install sprinklers and sprinkler fittings where ambient conditions may fall below the minimum or exceed the maximum listed or approved temperature ratings.
- DO NOT** install sprinklers that have been dropped or struck by another object, even if they do not appear damaged. Never install glass bulb sprinklers if the bulb is cracked or if there is a loss of liquid from the bulb. Discard and replace any sprinklers that are damaged or show signs of corrosion.
- Before installation, verify that the sprinkler is the proper model, orifice size, and temperature rating for the intended application.
- Protect wet piping systems from freezing temperatures.
- To avoid damage, install sprinklers into the fittings only after the sprinkler system piping is in place.

- DO NOT** paint, coat, plate, or alter sprinklers. Sprinklers that have been altered from their manufactured condition may not function properly and will void any agency listings and/or approvals and impact system integrity.
- DO NOT** test sprinklers with a heat source. The glass bulb can weaken or shatter if exposed to a heat source during testing.
- DO NOT** clean sprinklers with soapy water, detergents, ammonia, cleaning fluids, or other chemicals. Remove any dust, lint, etc. with a soft, dry cloth.
- Sprinklers that have operated **SHALL NOT** be reassembled or reused. When replacing sprinklers, use new sprinklers of the same type, orifice, temperature, and response.
- Inspect sprinklers on a regular basis for corrosion, mechanical damage, obstructions, etc. The frequency of inspections may vary due to corrosive atmospheres/water supplies and activities around the sprinklers.
- DO NOT** hang anything from or attach anything to sprinklers. Obstructing the discharge pattern will affect the sprinkler's performance in the event of a fire.
- If construction is altered, the building owner or their representative is responsible for referencing applicable standards to determine if additional sprinklers or other system adjustments are required.
- The building owner or their representative is responsible for maintaining the fire protection system in proper operating condition.
- After installation is complete, the entire sprinkler system shall be tested in accordance with applicable standards (NFPA 13, NFPA 25, etc.) that describe the care and maintenance of sprinkler systems. In addition, the authority having jurisdiction may have additional maintenance, testing, and inspection requirements that shall be followed. **NOTE:** A successful test is not a substitute for proper system installation and maintenance.

⚠ **WARNING**

- Replacement/relocation of Victaulic® FireLock™ Automatic Sprinklers SHALL be performed by qualified personnel familiar with the system's original design criteria, sprinkler listings/ approvals, and state and local codes (including NFPA 13 standards).**

Failure to follow this instruction could affect system performance during a fire, resulting in death or serious personal injury and property damage.

## STANDARD SPRINKLER INSTALLATION

### ⚠ WARNING

- **DO NOT** allow sealing material to enter the sprinkler's orifice or to contact the bulb or seal.
- **DO NOT** handle sprinklers by the deflector.
- **DO NOT** exceed the specified assembly torques.
- Verify that the sprinkler wrench engages **ONLY** the wrench boss of the sprinkler and not the frame, deflector, or bulb.
- Sprinklers cannot operate properly with bulb or link protectors in place.
- Bulb or link protectors shall be removed from all sprinklers before the sprinkler system is placed into service.
- **DO NOT** use any tools to remove protectors on sprinklers with glass bulbs.

Failure to follow these instructions may cause improper sprinkler operation, resulting in death or serious personal injury and property damage.

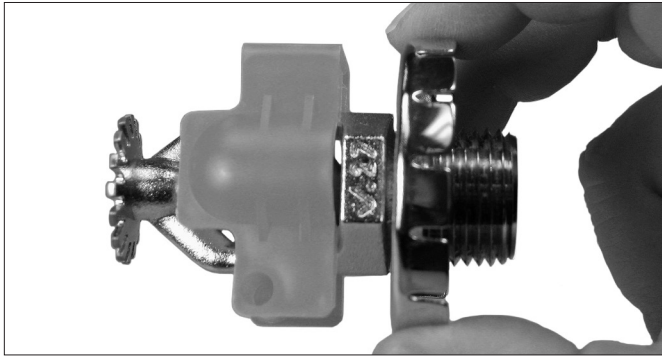

Each Victaulic® FireLock™ Automatic Sprinkler is shipped with a bulb or link protector, which protects from damage during shipment and installation. Bulb or link protectors shall remain installed until the sprinkler system is ready to be placed into service, or as instructed in step 4b or 5b below.

1. Inspect the sprinkler for any signs of physical damage and the glass bulb for cracks and loss of fluid. **DO NOT** install a sprinkler that has been dropped or damaged during handling.
2. **FOR RECESSED PRODUCT:** Install the collar onto the sprinkler. Verify that the collar is tightened completely up against the wrench boss, as shown to the left.
3. Apply two to three wraps of tape or a non-hardening pipe-joint compound to the male threads only.

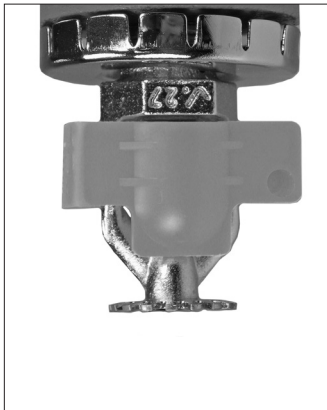

- 4a. Install the sprinkler in its intended orientation only. Thread the sprinkler into the fitting by hand, then tighten the sprinkler into the fitting by using the proper model sprinkler wrench (refer to the "Available Sprinkler Wrenches" table). Verify that the sprinkler wrench engages **ONLY** the wrench boss of the sprinkler. **DO NOT** engage the sprinkler wrench on the frame, deflector, or bulb. To obtain a proper seal, tighten the sprinkler securely to prevent leakage. **DO NOT** exceed the maximum assembly torque values listed in the following table.

Orifice Size	Maximum Torque
½-inch NPT	14 ft-lbs/19 N•m
¾-inch NPT	20 ft-lbs/27 N•m
1-inch NPT	30 ft-lbs/41 N•m

- 4b. Remove the bulb protector from all sprinklers carefully by hand before the sprinkler system is placed into service. **DO NOT use any tools to remove protectors on sprinklers with glass bulbs.** **NOTE:** Bulb protectors on all upright sprinklers, or on any sprinklers installed more than 10 feet/3 meters above the floor, can be removed immediately following installation.

5. **FOR RECESSED PRODUCT:** Install the escutcheon or cover plate by centering it over the sprinkler. Push the escutcheon onto the recess collar until it contacts the ceiling or sidewall.

**HOLE SIZES FOR ESCUTCHEONS**

Escutcheon Style(s)	Hole Sizes for Escutcheons inches/millimeters	
	Minimum	Maximum
Semi-Recessed	2 51	2 3/8 60
V27 Concealed	2 3/8 60	2 13/16 71
V29 Flush Pendent	1 5/8 41	2 51
V31/V32/V33/V35 Concealed	2 5/8 67	2 3/4 70
V36/V40 Plain, Extended, and Flush	1 1/2 38	2 1/2 63
V36/V40 Sleeve/Skirt	1 3/4 44	2 1/2 63
V38 Concealed	2 3/8 60	2 11/16 68
V41 Clamshell	1 7/8 48	2 1/8 54
V56/V81 "Inch" Concealed*	2 1/4 57	2 1/2 63
V49 "Inch" Concealed	2 3/4 70	2 7/8 73

\* Hole size can go up to 3 7/8 inches/98 mm maximum with seismic cover plate  
 NOTE: Always reference the applicable Victaulic product publication for cover plate information.

**SPRINKLER GUARD INSTALLATION**

**⚠ WARNING**

- Sprinkler guards shall be installed **AFTER** the sprinkler is installed and before the system is tested.
- Avoid damage to the frame, deflector, and bulb during sprinkler guard installation.

Failure to follow these instructions could cause improper sprinkler operation, resulting in death or serious personal injury and property damage.

**NOTICE**

- The photo to the right is intended only to show the clarity of guard and sprinkler features. Sprinkler guards shall be installed **AFTER** the sprinkler is installed properly into the fitting.

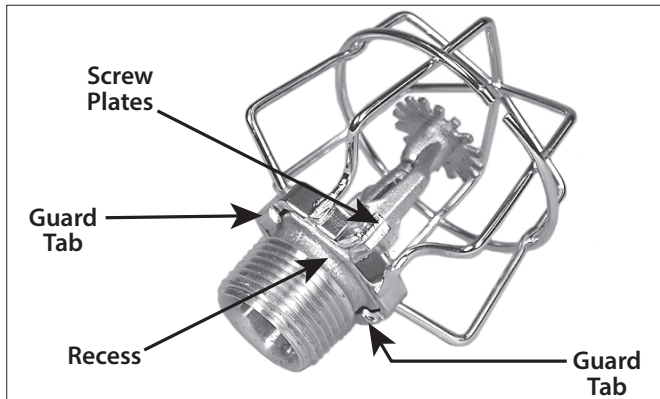

1. Install the guard onto the sprinkler. Verify that the tabs on the guard engage the recess between the wrench boss and threads of the sprinkler, as shown above.
2. Insert the two screws (provided) and tighten evenly until metal-to-metal contact occurs at the screw plates.

**TESTING SPRINKLER SYSTEMS**



After installation is complete, the entire sprinkler system shall be tested in accordance with current, applicable NFPA (NFPA 13, 13D, 13R, etc.) standards, or equivalent standards, and in accordance with applicable building and fire codes. In addition, the authority having jurisdiction may have additional maintenance, testing, and inspection requirements that shall be followed.

**NOTICE**

- A successful sprinkler system test is not a substitute for proper system installation and maintenance.

**SPRINKLER REPLACEMENT**

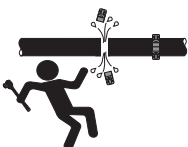
**⚠ WARNING**

- Always verify that the piping system has been completely depressurized and drained immediately prior to installation, removal, adjustment, or maintenance of any Victaulic products.
- Confirm that any equipment, branch lines, or sections of piping that may have been isolated for/during testing or due to valve closures/positioning are identified, depressurized, and drained immediately prior to installation, removal, adjustment, or maintenance of any Victaulic products.
- Any activities that require taking the valve out of service may eliminate the fire protection provided. A fire patrol is strongly recommended for the affected areas.
- Before servicing or testing the system, notify the authority having jurisdiction.

Failure to follow these instructions could result in death or serious personal injury and property damage.

1. **THE SYSTEM SHALL BE TAKEN OUT OF SERVICE IMMEDIATELY PRIOR TO REPLACEMENT OF SPRINKLERS.** Notify the authority having jurisdiction in the affected area that the fire protection system is being taken out of service and organize a fire patrol for the affected area.
2. Refer to the appropriate installation, maintenance, and testing manual for the system valve to relieve all pressure and drain all water from the system.
3. Remove the old sprinkler by using the proper sprinkler wrench. Install the new sprinkler in accordance with the instructions in the "Standard Sprinkler Installation" section on page 2 or the "Dry Sprinkler Installation" section on pages 5 – 7. Verify that sprinklers are replaced with the proper model, style, orifice size, temperature rating, and response.
4. Place the system back in service by following the instructions in the appropriate installation, maintenance, and testing manual for the system valve.
5. Check the system for leaks and make any repairs immediately.
6. **SPRINKLER SYSTEMS THAT HAVE BEEN SUBJECTED TO A FIRE SHALL BE RETURNED TO SERVICE AS SOON AS POSSIBLE.** The entire system shall be inspected for damage and obstructions. Any damaged system components or any sprinklers that have operated shall be replaced. Sprinklers that have been exposed to corrosive, combustible products or high ambient temperatures shall be replaced. Contact the authority having jurisdiction in the local area for replacement requirements.

**SPRINKLER WRENCH INFORMATION**

Description of Sprinkler Wrench or Bit	Part Number for Ordering Sprinkler Wrench	Applicable Sprinkler Models
V26 Foam Nozzle Wrench	ST71000000	V2601, V2603
V27 Open-End Wrench	ST01000000	V2703, V2704, V2707, V2708, V2709, V2710, V2721, V2722, V2725, V2726, V2727, V2728, V2738, V2740, V2744, V2752, V2753, V2754, V2758, V2762, V2763, V3701, V3702
V27-2 Concealed/Recessed Wrench	ST12000002	V2707, V2708, V2709, V2710, V2727, V2728, V2738, V2740, V2742, V2744, V2752, V2758, V2762, V2763, V3701, V3702
V32 Open-End Wrench	ST32000003	V3201, V3202, V3203, V3204
V31/V33 Concealed Wrench	ST33P00000	V3102, V3301, V3302, V3303, V3304
V34 Open-End Wrench	ST02000000	V3401, V3402, V3403, V3404, V3405, V3406, V3407, V3408, V3409, V3410, V3412, V3414, V3416, V3417, V3418, V3421, V3423, V3424, V3425, V3426, V3428, V3429, V3430
V34 Recessed Wrench	ST22000000	V3405, V3406, V3407, V3408, V3409, V3410, V3412, V3414, V3416, V3421, V3423, V3424, V3426, V3428
V36 Dry Open-End Wrench	ST73000000	V3601, V3602, V3603, V3604, V3605, V3606, V3607, V3608, V3609, V3610, V3611, V3612, V3613, V3614, V3615, V3616, V4001, V4002
V36 Dry Recessed and Concealed Wrench	ST43P00000	V3605, V3606, V3607, V3608, V3609, V3610, V3611, V3612, V3613, V3614, V3615, V3616, V4001, V4002
V38-4 Socket Concealed Wrench	ST21N00000	V3801, V3802, V3806, V3807, V3808
V38-5 Cabinet Socket Wrench	ST61000000	V3801, V3802, V3806, V3807, V3808
V46/V48 Open-End Wrench	ST93000900	V4601, V4603, V4802, V4804, V4806, V4808
V44/V47 Open-End Wrench	ST92000800	V4702
V49/V56 1-inch Adjustable Concealed Wrench	S332765000	V4906, V5603, V5606, V5648, V5653
V56 Open-End Wrench	S325390000	V2801, V2815, V2826, V2851, V2861, V2870, V3010, V4201, V4215, V4226, V4251, V4261, V4270, V4431, V5608, V5610, V5614, V5618, V5619, V5620, V5621, V5623, V5625
V56 Domed Concealed Wrench	S329678000	V5613
V56-2 Recessed Wrench	S325391000	V2801, V2826, V2851, V2870, V3010, V4201, V4226, V4251, V4270, V5610, V5614
V44 Recessed Wrench	ST42060000	V4431
V81 Domed Concealed Wrench	S329679000	V8113, V8114
V81 Attic/Conventional Wrench	S312366000	V8122, V8123, V8124, V8125, V8169
V56/V81 Concealed Dry & V11 Concealed ECLH Wrench	S337014000	V1106, V5634, V5689, V8134, V8189
V11 Recessed Wrench	S333011000	V1113
V11 Open-End Wrench	S333010000	V1113, V1121, V5643, V5687, V8143, V8187
Style V9 Coupling Bit	J000V09000	V2703, V2704, V2707, V2708, V2709, V2710, V2721, V2722, V3401, V3301, V3302, V3402, V3403, V3404, V3405, V3406, V3407, V3408, V3409, V3410, V3417, V3418, V3421, V3425, V3429, V3430, V3601, V3602, V3603, V3604, V3605, V3606, V3607, V3608, V3609, V3610, V3611, V3612, V3613, V3614, V3615, V3616, V4001, V4002, V4601, V4603, V4702, V4802, V4804, V4806, V4808, V5634, V5643, V8134, V8143

**NOTE:** For sprinkler wrench availability for discontinued product, reference the latest Fire Protection Price List for FireLock™ Devices and Sprinklers.

**DRY SPRINKLER INSTALLATION**

- Victaulic FireLock™ Dry Sprinklers shall be installed in accordance with current, applicable NFPA (NFPA 13, 13D, 13R, etc.) standards, or equivalent standards, and in accordance with applicable building and fire codes.
- Apply two to three wraps of tape or a non-hardening pipe-joint compound to the male threads only.
- Install dry sprinklers by using a wrench on the brass inlet fitting. When these installation methods are not possible, the proper sprinkler wrench can be used with extreme care for dry sprinkler lengths up to 18inches/457 mm.
- **DO NOT** use excessive torque during installation. Excessive torque can distort the sprinkler frame. When a Model V36 Sprinkler Wrench is used with a Model V36 Dry Sprinkler, or when a Model V34 Sprinkler Wrench is used with a Model V40 Dry Sprinkler, do not exceed 30ft-lbs/41 N•m. When a pipe wrench is used on the outer tube, do not exceed 40ft-lbs/54 N•m.
- Model V41 Dry ESFR Sprinklers are designed only for wet systems.
- Where systems incorporate IGS grooves for sprinkler connection, the Style V9 Victaulic® FireLock™ IGS™ Installation-Ready™ Sprinkler Coupling shall be used.



SCAN CODE TO DOWNLOAD THE I-V9 INSTALLATION INSTRUCTIONS ON VICTAULIC.COM

**DRY SYSTEMS:** Dry sprinklers designed for use in dry systems shall be installed only into the outlet of a fitting (excluding elbows) or welded outlet that meets the dimensional requirements of ANSI B16.3 and ANSI B16.4, Class 125 and Class 150. Use a sample fitting to confirm proper engagement and to verify that there is no interference between the sprinkler and fitting. To ensure unobstructed flow during operation, and for applications where systems are subjected to freezing temperatures, the dry sprinkler shall be installed into a fitting that will prevent condensation from accumulating above the seal.

**WET SYSTEMS:** The inlet of the dry sprinkler **SHALL NOT** bottom out in the fitting. **DO NOT** install dry sprinklers into any threaded elbow, thread-by-thread coupling, or fitting that interferes with thread penetration. Dry sprinklers can be installed into the outlets of Style 920/Style 920N *Mechanical-T* Bolted Branch Outlets, Style 922 FireLock™ *Outlet-T* products, and No. 141 IGS™ Grooved x Female Threaded Adapter Nipples. Dry Sprinklers can be installed into CPVC fittings (excluding elbows) that do not interfere with thread penetration. Use a sample fitting to confirm proper engagement. Verify that the exposed minimum barrel length in the heated space is measured and maintained in accordance with the table below.

The table below is used when the ambient temperature is maintained between 40°F/4°C and 60°F/16°C around the wet piping system.

**EXPOSED BARREL AMBIENT TEMPERATURE (°F/°C)**

Ambient Temperature Exposed to Discharge End of Sprinkler °F/°C	“C” – Minimum Exposed Barrel Length when Exposed to 40°F/4°C inches/mm	“C” – Minimum Exposed Barrel Length when Exposed to 50°F/10°C inches/mm	“C” – Minimum Exposed Barrel Length when Exposed to 60°F/16°C inches/mm
40 4	0 0	0 0	0 0
30 -1	0 0	0 0	0 0
20 -7	4 100	0 0	0 0
10 -12	8 200	1 25	0 0
0 -18	12 300	3 75	0 0
-10 -23	14 350	4 100	1 25
-20 -29	14 350	6 150	3 75
-30 -34	16 400	8 200	4 100
-40 -40	18 450	8 200	4 100
-50 -46	20 500	10 250	6 150
-60 -51	20 500	10 250	6 150

Exposed minimum barrel lengths are inclusive up to 30-mph/48-kph wind velocities

**DRY SPRINKLER INSTALLATION (CONTINUED)**

**NOTICE**

- The "F" dimension of an ESFR dry sprinkler, which extends into a freezer from a wet piping system, shall take into account the freezer ceiling thickness and the required length below the freezer ceiling. The minimum length of the dry sprinkler shall not be less than the lengths specified in the "Exposed Barrel Ambient Temperature (°F/°C)" table on page 5, plus the required length below the freezer ceiling ("F" = "C" + "D" + "E").
- Refer to the drawing on this page for a representation of the "F" dimension. **DO NOT** attempt to modify dry sprinklers.
- Illustrations are exaggerated for clarity and are provided only as examples. Refer to the specific product publication for complete information.

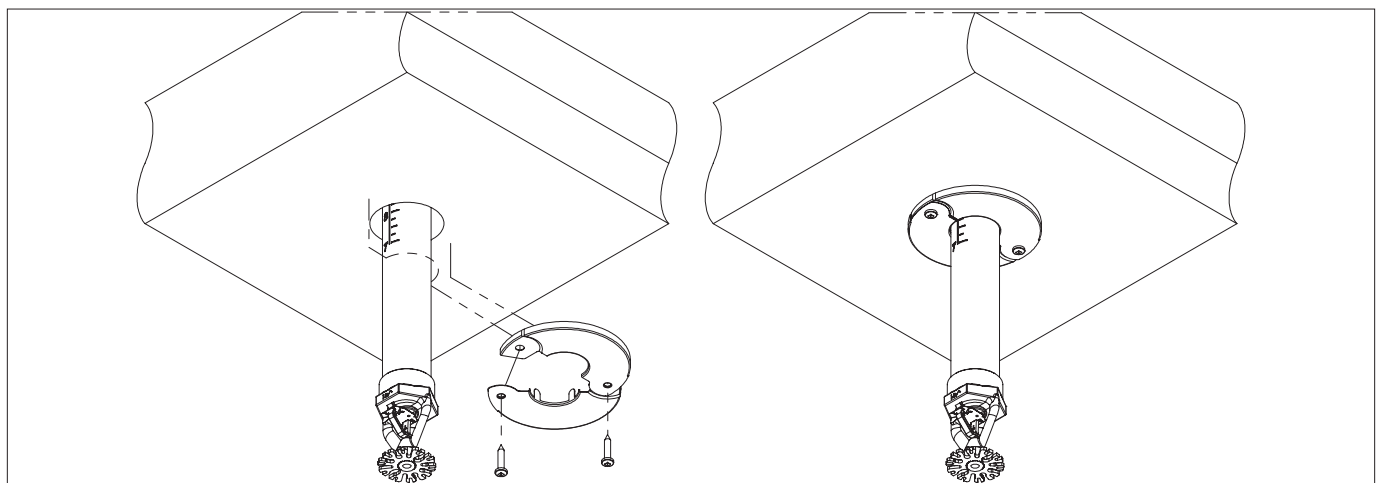
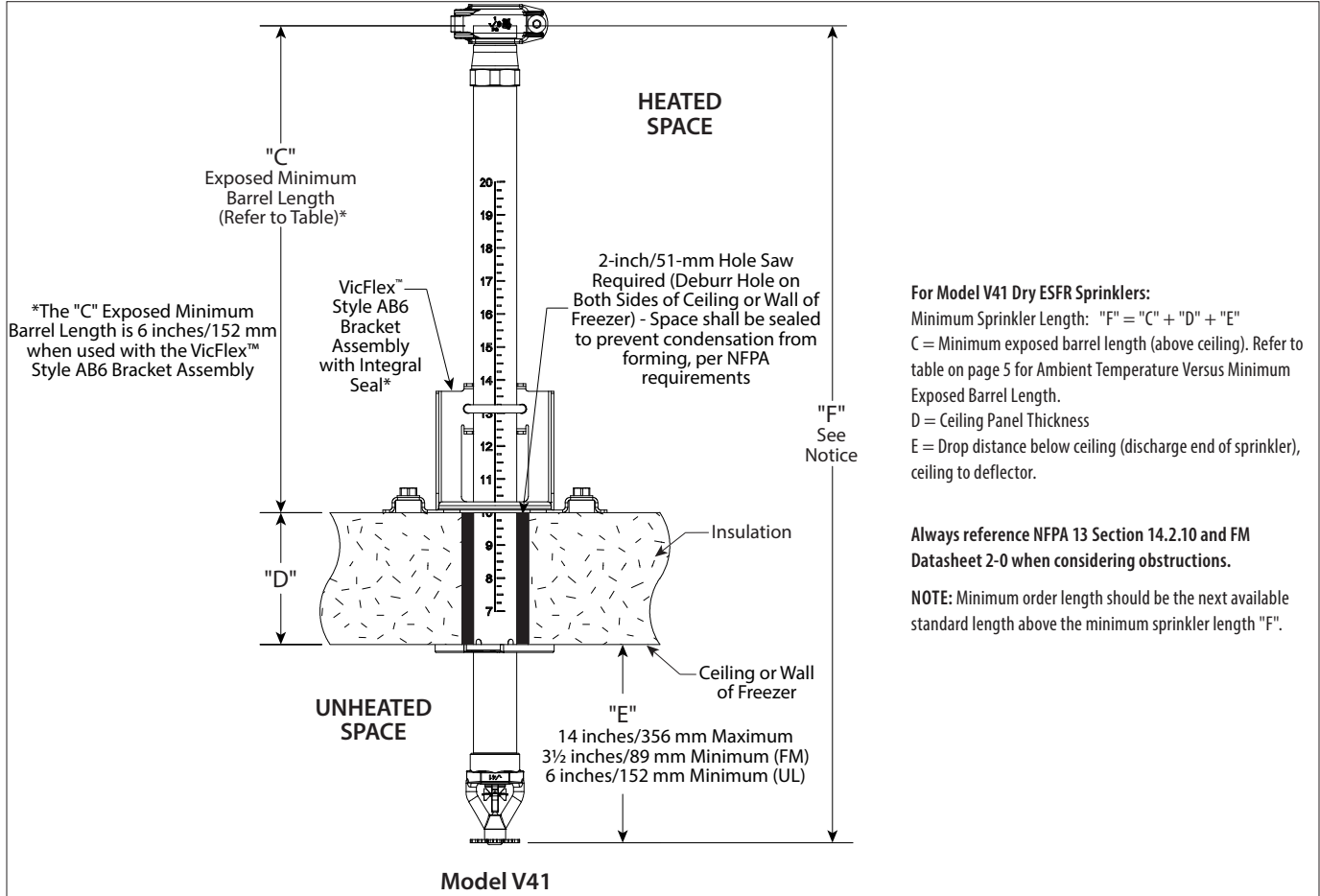

Install the escutcheon of the Model V41 Dry ESFR Sprinkler, as shown in the drawings above. Use the No. 8 self-piercing sheet metal screws provided with the product to attach the escutcheon to the freezer's ceiling or wall panel.



**DRY SPRINKLER INSTALLATION (CONTINUED)**



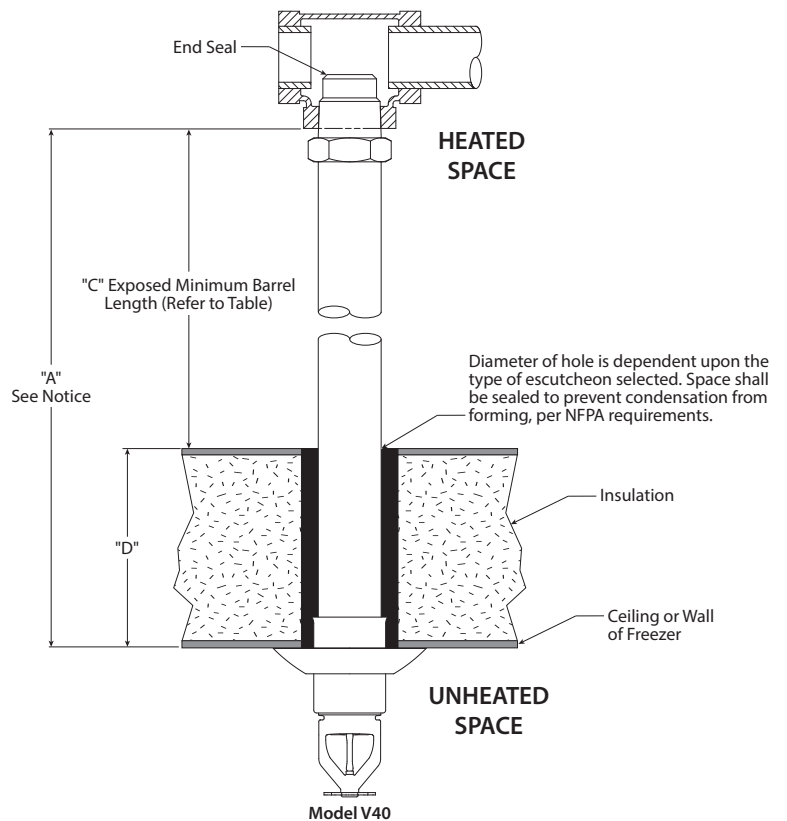
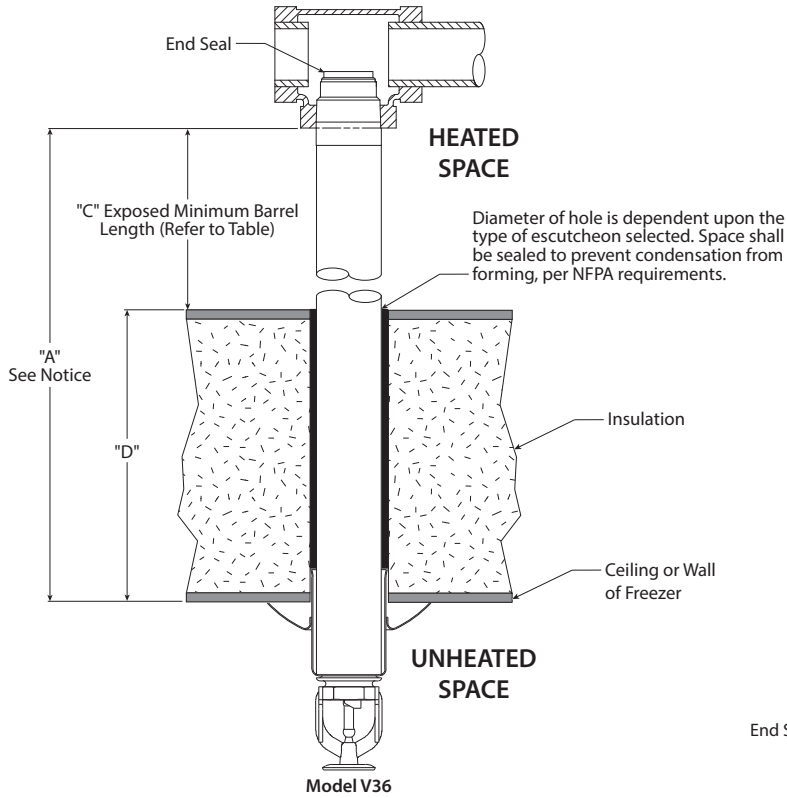

**NOTICE**

- The "A" dimension of a dry sprinkler, which extends into a freezer from a wet piping system, shall take into account the wall or ceiling thickness of the freezer. The minimum length of the dry sprinkler shall not be less than the lengths specified in the "Exposed Barrel Ambient Temperature (°F/°C)" table on page 5, plus the thickness of the freezer's ceiling or wall ("A" = "C" + "D").
- Refer to the drawings on this page for a representation of the "A" dimension. DO NOT attempt to modify dry sprinklers, since they are manufactured to this specific "A" dimension.
- Illustrations are exaggerated for clarity and are provided only as examples. Refer to the specific product publication for complete information.



# Victaulic® FireLock™ Automatic Sprinklers

## European and UK Certifications

SIN				
	Approval Number*	Reference Number*	Certificate of Conformity*	Certificate of Conformity*
V2703	G 4020046	104b/01	0786-CPD-40004 0786-CPD-40235	0832-UKCA-CPR-S5062
V2704	G 4020043	104b/02	0786-CPD-40001 0786-CPR-40258	0832-UKCA-CPR-S5064
V2709	-	104b/01	2831-CPR-S0005	0832-UKCA-CPR-S5050
V2710	-	104b/02	2831-CPR-S0006	0832-UKCA-CPR-S5050
V2725	G 4020048	104b/01	0786-CPD-40006 0786-CPR-40262	0832-UKCA-CPR-S5068
V2726	G 4020045	104b/02	0786-CPD-40003 0786-CPR-40260	0832-UKCA-CPR-S5066
V2727	G 4020047	104b/01	0786-CPD-40005 0786-CPR-40260	0832-UKCA-CPR-S5067
V2728	G 4020044	104b/02	0786-CPD-40002 0786-CPR-40259	0832-UKCA-CPR-40259
V2762	G 422049	104B/10	0786-CPR-40345 0786-CPR-40346	-
V2763	G 422048	104b/09	0786-CPR-40347 0786-CPR-40348	-
V3401	G 4020051	104b/03	0786-CPD-40009 0786-CPR-40236	0832-UKCA-CPR-S5063
V3402	G 4020049	104b/04	0786-CPD-40007 0786-CPR-40263	0832-UKCA-CPR-S5069
V3403	G 416015	-	-	-
V3404	G 414050	-	-	-
V3423	G 4020052	104b/03	0786-CPD-40010 0786-CPR-40265	0832-UKCA-CPR-S5071
V3424	G 4020050	104b/04	0786-CPD-40008 0786-CPR-40264	0832-UKCA-CPR-S5070
V3613	-	-	2809-CPR-F0060-01	-
V3614	-	-	2809-CPR-F0061-01	-
V3615	-	-	2809-CPR-F0062-01	-
V3616	-	-	2809-CPR-F0063-01	-
V3701	G 423014	104b/11	0786-CPR-40349 0786-CPR-40350	-
V3702	G 423015	104b/12	0786-CPR-40351 0786-CPR-40352	-
V3801	-	104b/05	2831-CPR-S0003	0832-UKCA-CPR-S5049
V3802	-	104b/06	2831-CPR-S0003	0832-UKCA-CPR-S5049

\* Tested to EN12259-1

For complete contact information, visit [victaulic.com](http://victaulic.com)

I-40 2239 REV Y UPDATED 04/2024 Z000SPK002

VICTAULIC, FIRELOCK, IGS, AND INSTALLATION-READY ARE REGISTERED TRADEMARKS OR TRADEMARKS OF VICTAULIC COMPANY AND/OR ITS AFFILIATED ENTITIES IN THE UNITED STATES AND/OR OTHER COUNTRIES. © 2024 VICTAULIC COMPANY. ALL RIGHTS RESERVED.

